

Driveway Lite

PROJECT:
TYPE:
SOURCE:
NOTES:

PURELED SPECIFICATIONS

LED Chip	Cree XHP-50-2 Plug and Play field replaceable LED board
Luminaire Output	600 Lumens @ 1050mA (6 watts), 420 Lumens @ 700mA (4 watts), 240 Lumens @ 350mA (2 watts), delivered from luminaire with unobstructed beam.
Lumens Per Watt	100 Lumens @ 6 watts minimum, delivered from luminaire with unobstructed beam
CRI (3000K)	90+
Colour Temperatures	2700K, 3000K, 4000K
Beam Angles	15, 25, 38, 60
Ingress Protection	IP68 *not for use in pool or ponds
Warranty	Electronics = 5 years Flange SBZ/SS = 10 years Body Aluminium = 5 years
Standards	AS/NZS 61046 cUL 1838, 2108 CSA 22.2 No. 250.7, No. 250.0-08, CE

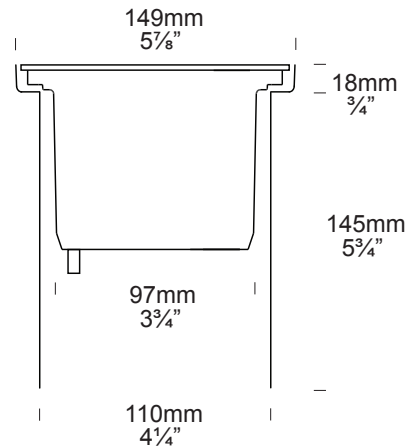

PRODUCT CONFIGURATION

Please fill in appropriate codes into boxes provided

Cat. No. DWL/L

Luminaire	Power	Material/ Finish	Beam	Colour	Accessories
DWL/L					
S SERIES, REMOTE DRIVER		SS STAINLESS STEEL	15 15°	2 2700K	HCR HEX CELL RETAINER
D3 12VAC, 2W INTEGRAL		SBZ SOLID BRONZE	25 25°	3 3000K	CJK CABLE JOINT KIT
D7 12VAC, 4W INTEGRAL			38 38°	4 4000K	LENSLLF FROSTED LENS
D10 12VAC, 6W INTEGRAL			60 60°		GS05 GLARE SHIELD
D24 24VDC DRIVER					

SERIES, REMOTE DRIVER REQUIRED:

Constant current driver
Individual fixtures require 6vdc @ 1050mA maximum

12VAC INTEGRAL DRIVER:

Hunza integrated plug and play driver (included)
Input: 9-15VAC.
Output: 6vdc @ D3=350mA, D7=700mA, D10=1050mA (1050mA limited to ≤ 40°C (104°F) ambient temperature in stainless steel)

24VDC DRIVER:

Input: 24vdc.
Output: 18vdc @ 700mA constant current (non dimming).
Note: not for USA.

OTHER LAMP OPTIONS:

DWL/H - MR16 Halogen 12V Lamp
DWL/SL - MR16 LED Retrofit 12V Lamp (lamps vary by market - please refer to supplier for details)
DWL/GUH - GU10 120/240V Halogen Lamp
DWL/GUSL - GU10 LED Retrofit 120/240V Lamp (lamps vary by market - please refer to supplier for details)

[Click here for halogen specification sheet](#)

[Click here for 240v Remote Power Supply Guidance Charts](#)

[Click here for USA Remote Power Supply Guidance Charts](#)

LUMINAIRE CONSTRUCTION

CNC machined from one of the following metals:

Aluminium:

Body: cast from high corrosion resistant CC401 low copper aluminium alloy, with chromate substrate and high UV resistant polyester double powder coated.
Colour: Black

Solid Bronze:

Flange: solid bronze bar 150mm (6")

316 Stainless Steel:

Flange: 316 stainless steel 150mm (6") rod.

Flange:

The flange is attached to the body by three 316 stainless steel allen head anti vandal screws.

Lens:

12mm (1/2") extra clear, low iron, flush fit, shatter resistant glass.
Lifetime warranty

Gaskets:

Silicone 220°C (428°F)

Adjustability:

The gimbal is fully adjustable, allowing 360° rotation and 0-20° elevation.

Mounting:

Supplied with mounting canister for casting in concrete to facilitate ease of installation. The luminaire can be driven over or walked upon without being damaged. Maximum drive over speed 10km/h (6 mph) and weight 1500kg (3300lbs)

Luminaire Weight:

Low voltage
SBZ: 1.950kg (4lb 4oz)
SS: 1.900kg (4lb 3oz)

ACCESSORIES

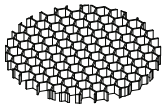

Hex Cell Retainer

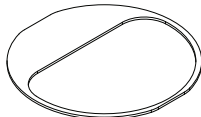

Glare Shield

BEAM ANGLES

High efficiency PMMA TIR lenses. Field replaceable

IES files available for download: hunzalighting.com/downloads

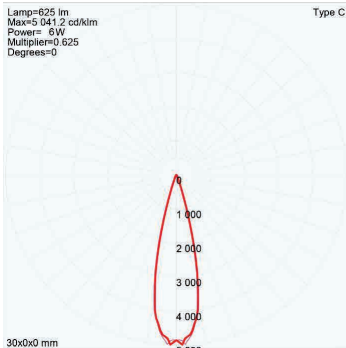

15° FWHM TIR

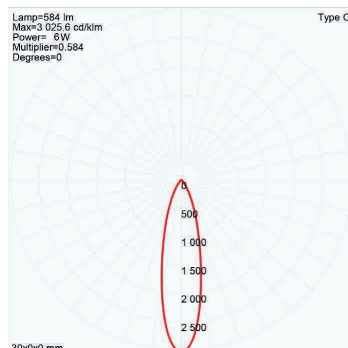

25° FWHM TIR

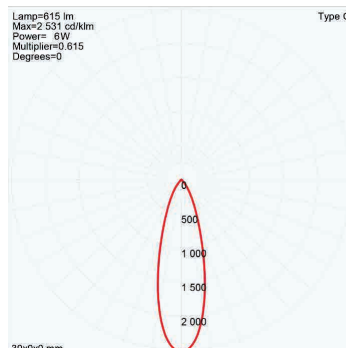

38° FWHM TIR

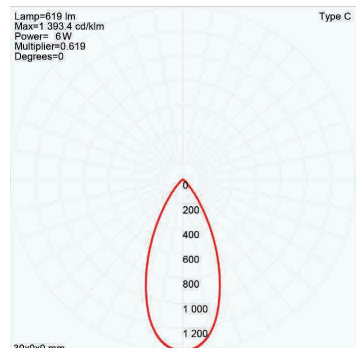

60° FWHM TIR

WIRING GUIDE

Available for download: hunzalighting.com/downloads

Series/remote driver

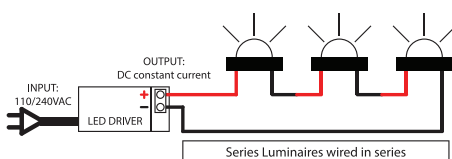

12v integral driver

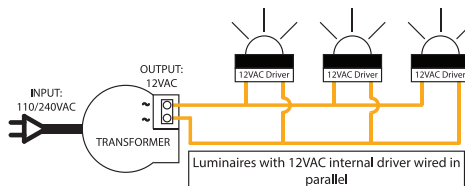

24vdc integral driver

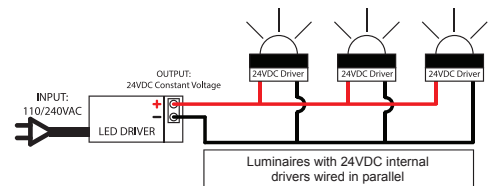

Diagrams are a guide only, wire colours and polarity may change depending on fixture and country

Specifications may change without notification

Aug 2017